

PREINSTALLATION
VORINSTALLATION

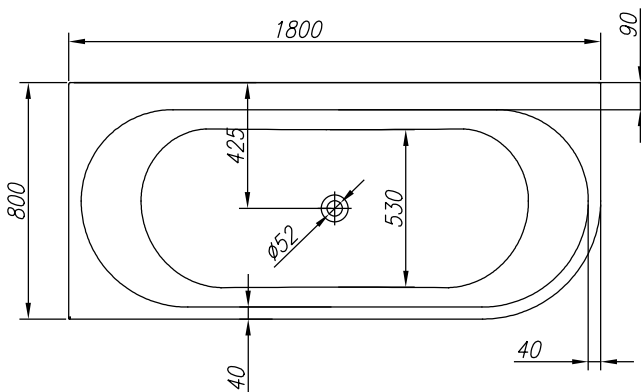
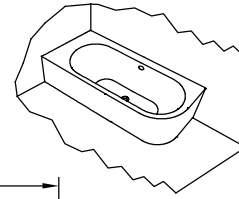
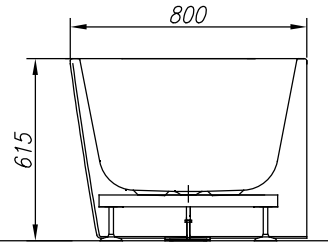
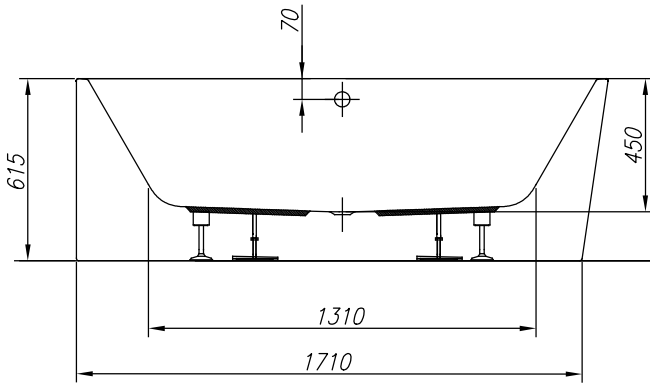

VOLUME (l)
VOLUMEN (l)

MAX. LOAD (kg)
MAX. BELASTUNG (kg)

FLOOR LOAD (kg/m²)
BODENBELASTUNG (kg/m²)

245

400

280

- - Spot for el. cable 3×2.5mm², length approx. 1m
- - Platz Stromkabel 3 × 2,5 mm², Länge cca. 1 m
- - Spot for el. cable 1×6mm² for earthing, length approx. 1.5m
- - Platz Stromkabel 1 × 6 mm² für Erdung, Länge cca. 1,5 m

- ⊠ - Connection of hot and cold water 1/2" min 0.2Mpa, max 0.4Mpa
- ⊠ - Anschluss Warm- und Kaltwasser 1/2" min 0,2 Mpa, max 0,4 Mpa
- - Drain spot Ø 50mm
- - Abflussplatz Ø 50 mm

INSTALLATION RECOMMENDATION
MONTAGEEMPFEHLUNG

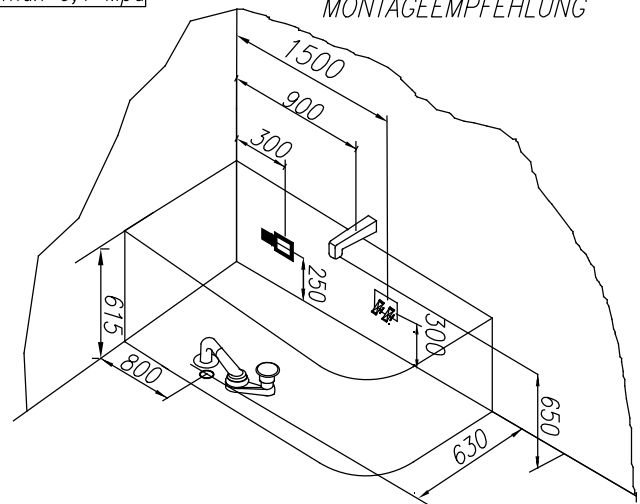

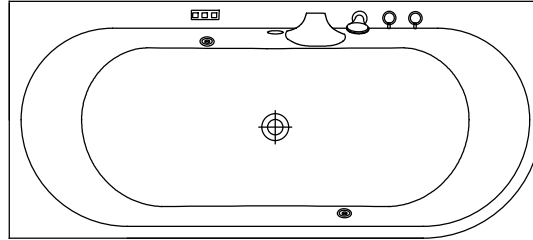
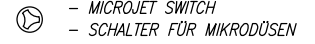
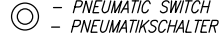
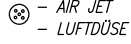
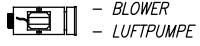
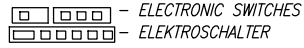
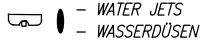
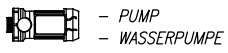

- OPTION FIXTURE AND SHOWER HANDLE - MÖGLICHKEIT WASSERHAHN UND DUSCHE

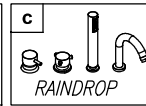
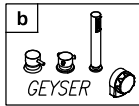
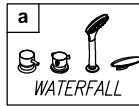

- OPTION CHROMOTHERAPY

- MÖGLICHKEIT CHROMOTHERAPIE

